

SCHEMA TECNICA - VASCHE PER MATERIALI DI SERIE

TECHNICAL SHEET - BASIN FOR SERIAL MATERIAL

Vasca per Solid e Mineralmarmarmo

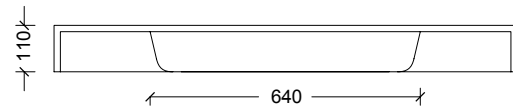
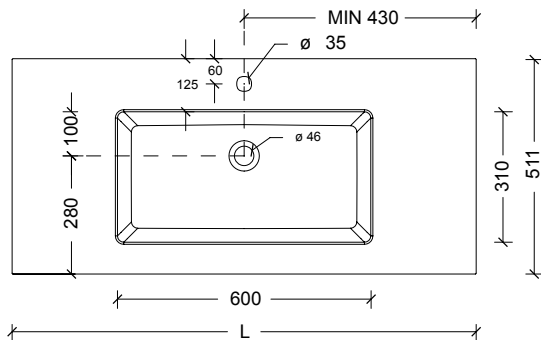

Vasca per Vetro

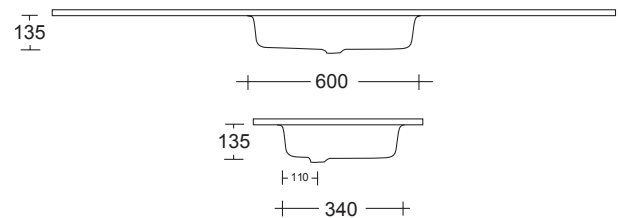
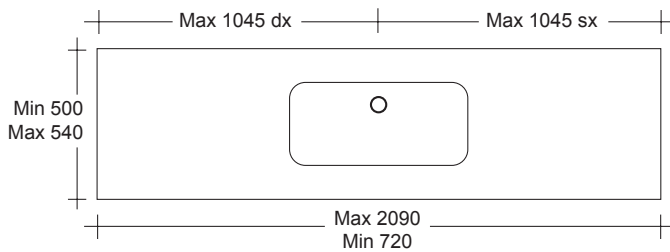

Vasca per Ecocemento

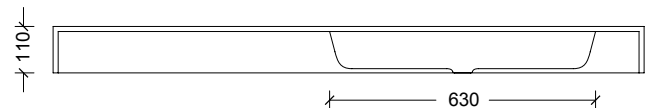
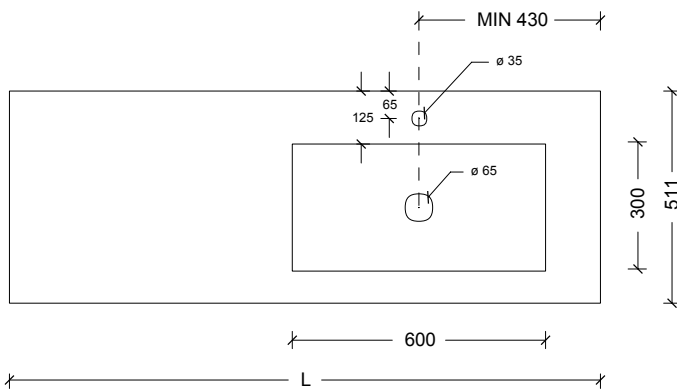

Vasca per GRES (706 X 306)

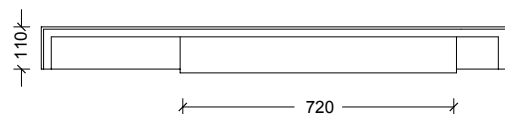
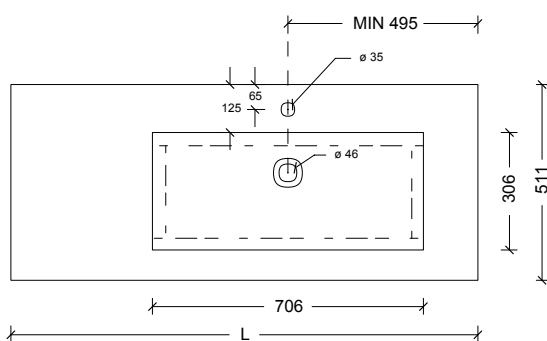

Controllare gli articoli prima della posa in opera. Non si accettano contestazioni per difetti riscontrati successivamente all'installazione
Check the items before installation. Not accept disputes for defects afterwards to the installation

Vasca per GRES (506 X 306)

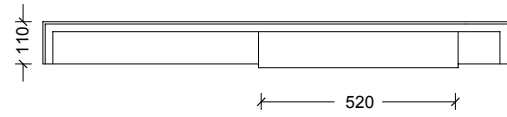
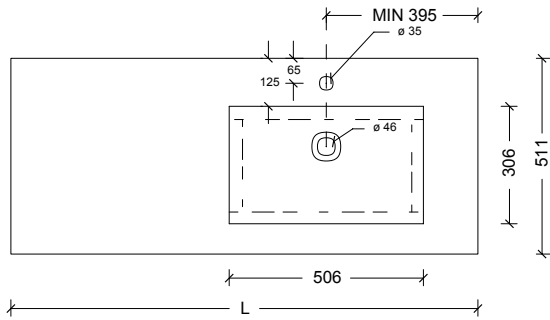

Vasca per HPL e FENIX (700 x 310)

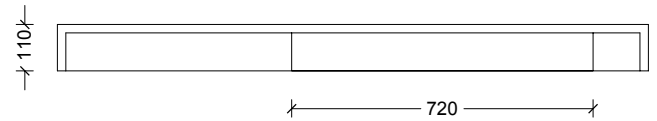
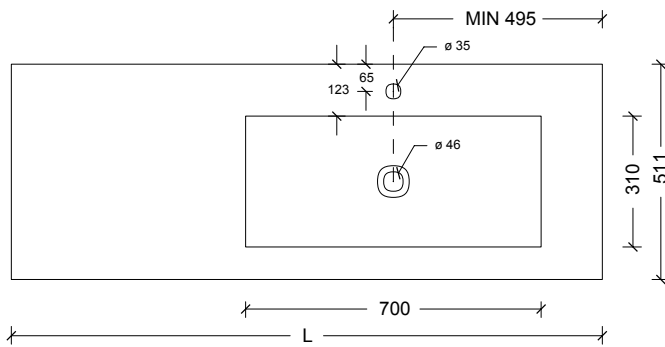

Vasca per HPL e FENIX (500 x 310)

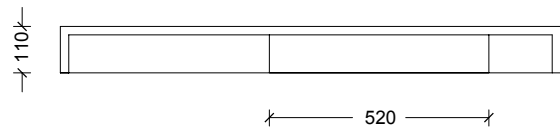
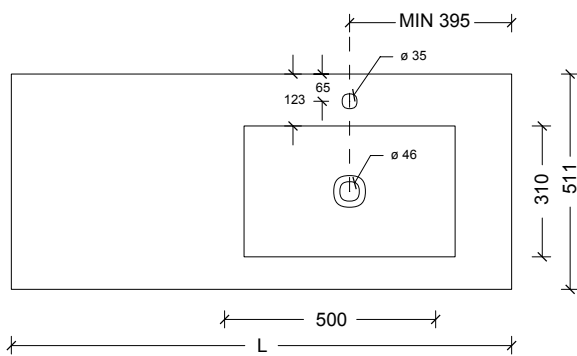

Controllare gli articoli prima della posa in opera. Non si accettano contestazioni per difetti riscontrati successivamente all'installazione
Check the items before installation. Not accept disputes for defects afterwards to the installation